

22 512 892



- Ausladung 135 mm
- schwenkbarer Auslauf 360°
- runder luftangereicherter Strahl
- Armaturenhöhe 275 mm
- Höhe bis Luftsprudler 168 mm
- Bohrungsdurchmesser 35 mm
- Rosette Ø 59 mm
- 2x Druckschlauch M 10 x 1 eingeschraubt, dichtheitsgeprüft
- Durchfluss max. 7 l/min
- bleifrei
- Dieses Produkt leistet einen Beitrag zur Erfüllung der Vorgaben von nachhaltigen Gebäudezertifizierungen, z.B. LEED®, BREEAM®, DGNB

Nur für Becken mit Überlauf geeignet.

	Schwarz matt	22 512 892-33
	Chrom	22 512 892-00
	Platin gebürstet	22 512 892-06
	Platin	22 512 892-08
	Dark Chrome	22 512 892-19
	Messing gebürstet (23kt Gold)	22 512 892-28
	Champagne gebürstet (22kt Gold)	22 512 892-46
	Champagne (22kt Gold)	22 512 892-47
	Chrom gebürstet	22 512 892-93
	Dark Platin gebürstet	22 512 892-99

22 512 892

mm [inches]

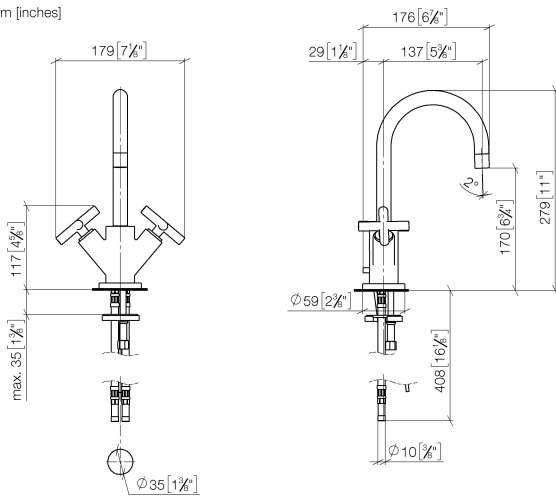

Durchflussdiagramm



Zertifikate

ETA_18512.

WRAS_1810003.

LGA_18920.

GDV_0400194.

22 512 892

Ersatzteile für die
anderen
Oberflächenvarianten
finden Sie hier:
Chrom

